

Installer Manual

DO NOT GIVE TO HOME OWNER
FOR PROFESSIONAL USE ONLY

Multicom CLASSIC



Note: For legal reasons, telephone technical support is for registered and qualified product dealers only. Home owners and end-users should contact their dealer for product technical support.



Contents

Important things to know	Pg 3
A look around the product	Pg 4
Cellular module in detail	Pg 5
Wiring relays	Pg 5
Keypad / prox modules in detail	Pg 6
Connecting slave devices	Pg 6
Inserting the SIM card	Pg 7
Powering up	Pg 7
PC Programming	Pg 8
PC software overview	Pg 9
Resident / family screen	Pg10
Visitor screen section	Pg11
Settings	Pg12
The APP	Pg13
Programming a new or existing job site	Pg14
Programming codes	Pg15
Programming (steps 1-3)	Pg16
Add a family	Pg17
Edit a family	Pg18
Activate auto sync	Pg19
Add visitor access	Pg19
A closer look at keypad codes	Pg20
A closer look at proc cards	Pg21
A closer look at callerID visitor access	Pg22
Do not disturb	Pg23
Access control (enable callerID & latching)	Pg23
Auto opening	Pg24
Enquire residents info	Pg25
Concierge / Manager/help button	Pg25
More settings	Pg26
Volumes	Pg26
Dialling times	Pg27
Relay times	Pg27
Information Screen	Pg28
Manager control of gate/door	Pg29
Calling a resident	Pg30
Using keypad codes	Pg30
Answering a call from the intercom	Pg31
Access control by callerID	PG31
Complete list of parameters	PG32

Really Important things you Need to Know..



Please read this entire manual before installing this product.



To be installed by certified and qualified personnel / gate automation dealer only. **Not for DIY install!!**



Ensure there is good 4G signal on site for best performance, however this unit will fall back to 3G service in some countries, and also 2G service in most of Europe.



Set up on a bench in workshop **BEFORE** going to site. Program the unit in the comfort of your work bench and call technical support should you have questions.



This product requires a voice SIM card. In order to make voice calls on 4G and get optimum service, your SIM and provider will need to offer VOLTE support (Voice over LTE) otherwise the unit will be forced to fall back to 3G or 2G service to make calls.

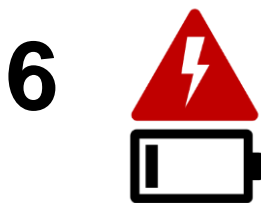

Fit proper power cable as per instructions! Do not use CAT5 to power this device as this will damage the product. Warranty will be VOID!

Now lets have a look around the product...

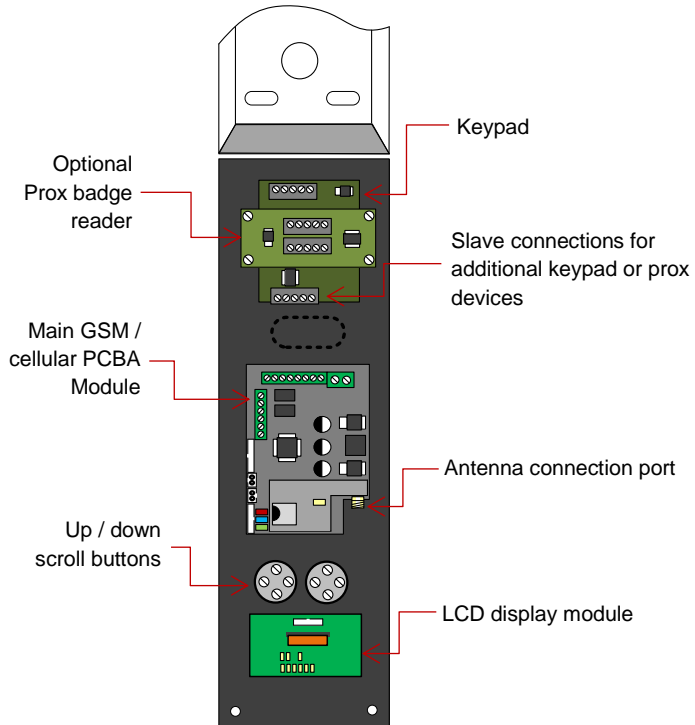
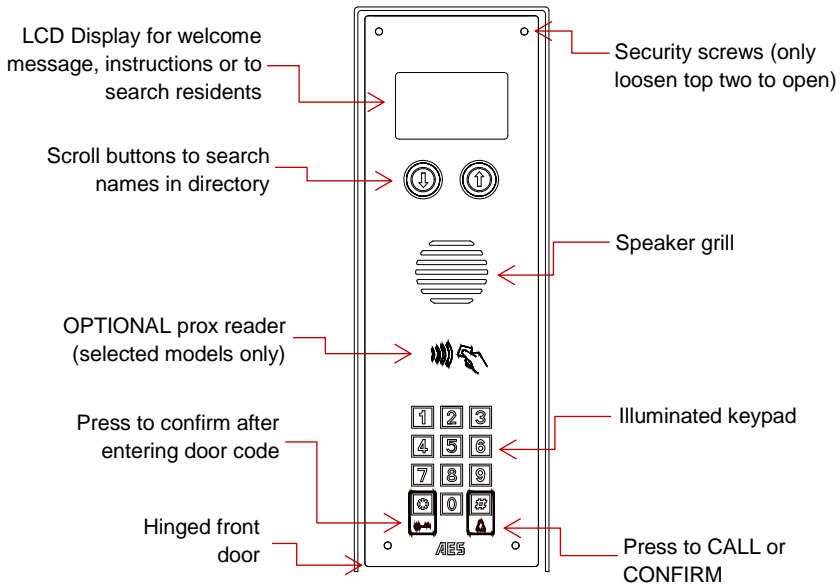

Cellular Module in Detail...

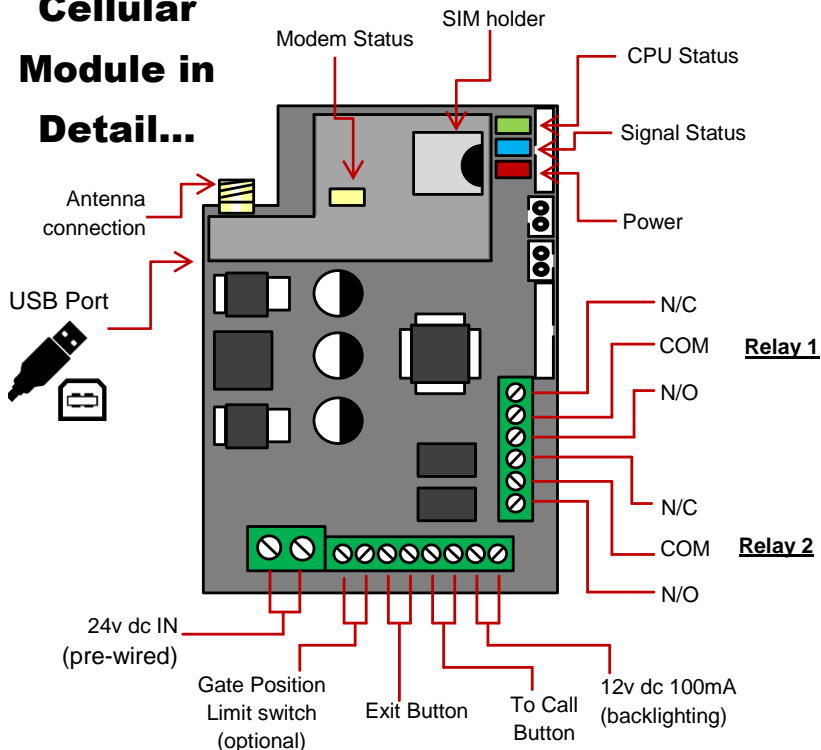

Wiring Relays

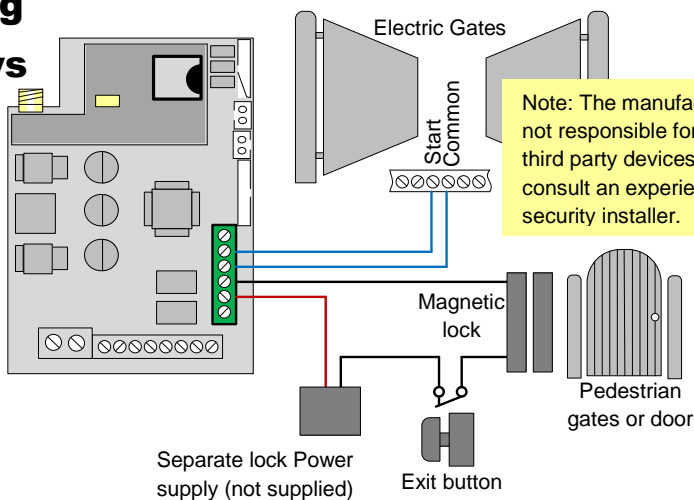

Note: The manufacturer is not responsible for wiring to third party devices. Please consult an experienced security installer.

Keypad / PROX Modules in Detail...

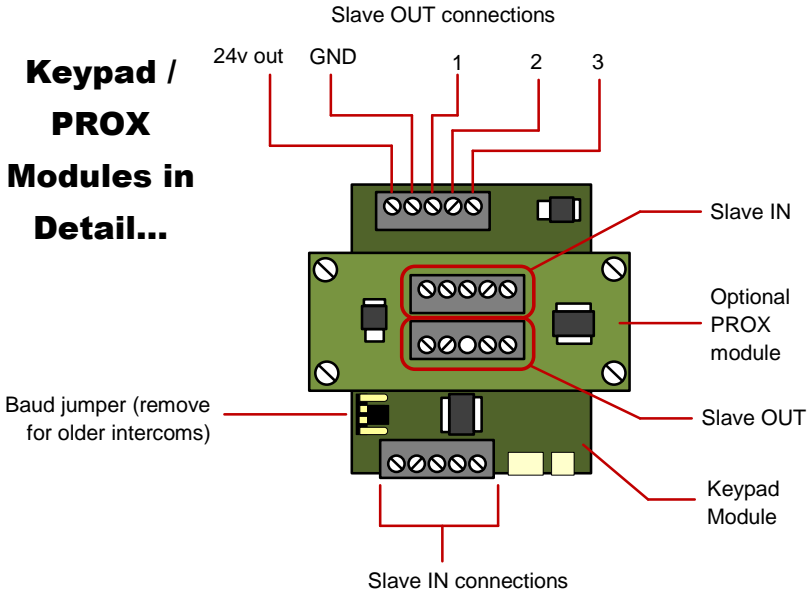

Connecting Slave Devices

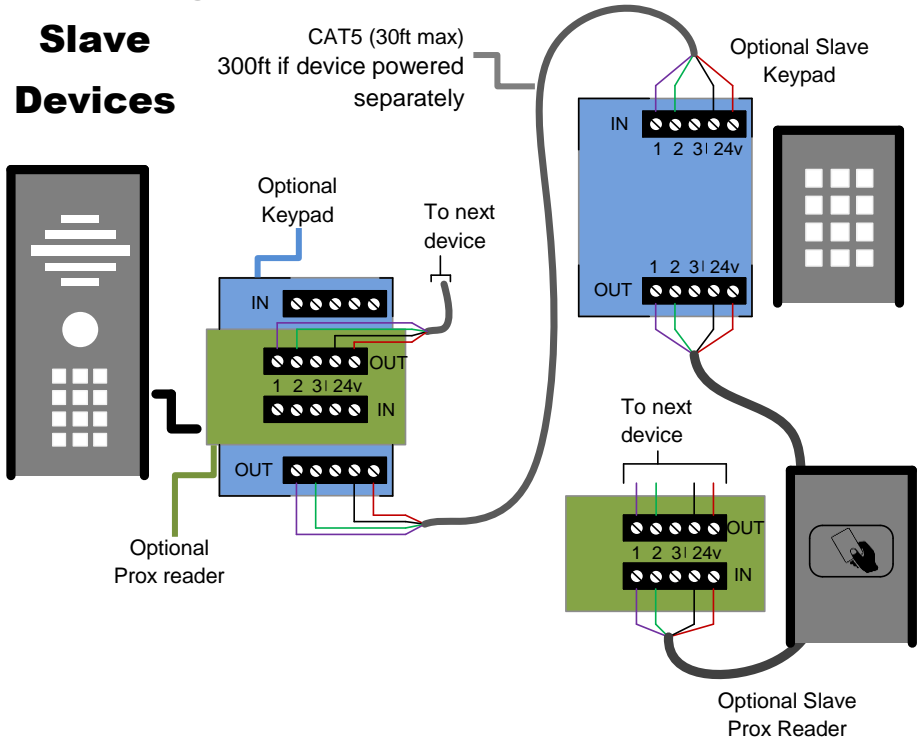

Inserting the SIM card

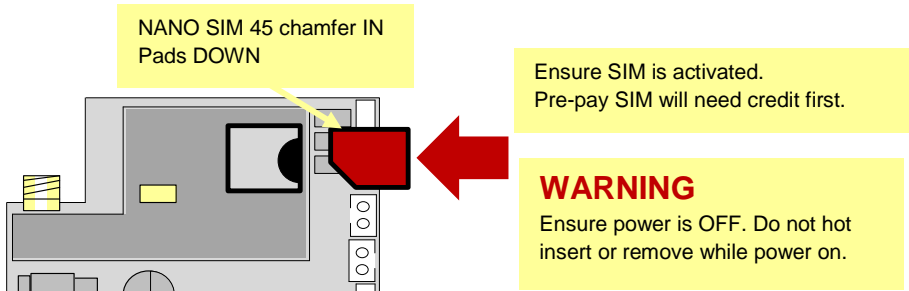

Powering Up & LEDs

Perform a final check of wiring and ensure the antenna is connected before switching on the power. Once the power is switched on, the power LED should illuminate.

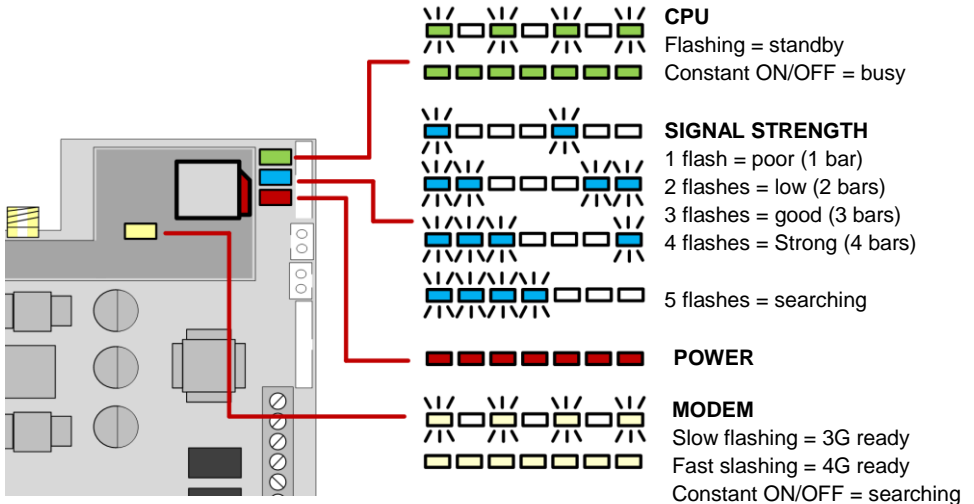

PC Programming

1

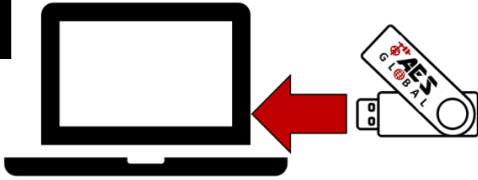

Use provided USB drive to copy MULTICOM CLASSIC software folder to PC (suggest copy to desktop for easy retrieval later).

2

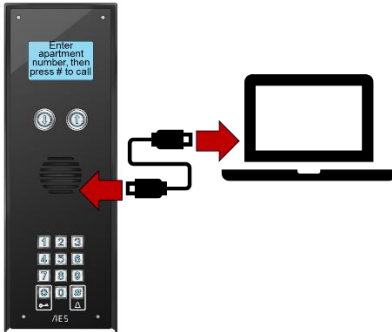

Connect provided USB cable to windows PC (windows 10 or later)

3

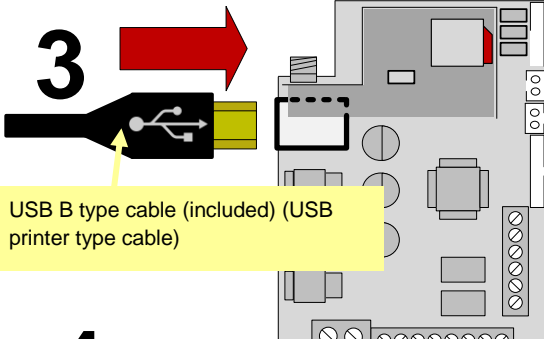

Insert the USB cable provided into the port shown. This can be done while the unit is powered on.

TIP: The intercom will need to be powered on, and have a working SIM card and be connected to the cellular network before PC programming can begin.

4



Open Multicom Classic folder

Copy the SHORTCUT icon to desktop for convenience

Double click and open software

PC Software Overview

The PC software has 3 tabs. Information can be downloaded from the intercom individually on each tab, edited, saved if needed, and uploaded back to the intercom again.

1. Enter default Engineers Passcode (9999) then press connect button

2. Enter or edit cells of data and use buttons below accordingly

	1	2	3	4	5	6	7	8	9
1	1001	Jones	0123456789	987654321	112233445566				
2	1002	Adams	998877665544						
3	1003	Lopez	1212343456						
4	1004	Goldberg	001002345	99887766543					
5	1005	O'Brien	9990001234						
6	1006	Smith	012345789						
7									
8									
9									

Enter optional site name

Open an existing PC file to upload to the intercom

Backup and save current data and settings to the PC

Download any current data from the intercom to the PC software for editing

Upload new data to the intercom to program it.

Resident / Family Screen

On the family data screen you can enter apartment number, family name, up to 3 phone numbers per family and other details as shown. This model will store up to 500 families.

Enter family name (will be displayed on directory) 14 digits max

Enter up to 3 phone numbers per family

The screenshot shows a software interface with a window titled "Family_data". At the top, there are tabs for "Family_data", "Visitor_data", and "Settings". Below the tabs is a search bar with three asterisks and a "****" placeholder, and a small icon of a person with a phone. The main area is a table with columns for apartment number, family name, and up to three phone numbers. The table contains the following data:

	1	2	3			
1	1001	Adams	0123456789	0887766543		112233
2	1002	Smith	987654321	0112233445	0123456777	223344
3	1003	Lopez	01201234567			123456
4	1004	Valdez	9898983245			654321
5						

Below the table is a form with a phone icon, a keypad icon, and a "00" input field. To the right of the form are three keypad pin code input fields labeled "1", "2", and "3". At the bottom of the screen are four icons: a refresh icon, a keypad icon, a download icon, and an upload icon.

Enter Apartment or house number (5 digits max)

For panels with Concierge / manager or help button, enter a phone number here

Enter keypad pin code, 1 per family (must be 6 digits)

Enter up to 3 Prox card serial numbers per family (10 digit card number)

Visitor Screen Section

On the visitor screen, there are 3 main sections...

1. Keypad pin codes.
2. Caller ID access (visitors can call the intercom to gain access by caller ID number recognition).
3. Proximity card section. Note Prox card storage is only available in certain hardware models fitted with a Prox reader.

Enter 50 permanent visitor keypad codes (4 digit). Choose relay 1 or 2, and set the trigger time.

Enter 20 time restricted visitor keypad codes (4 digit). Set start and end times in 24 hr format, no colon. Select days.

Enter 20 temporary codes, and set active time, from 1 – 168 hours.

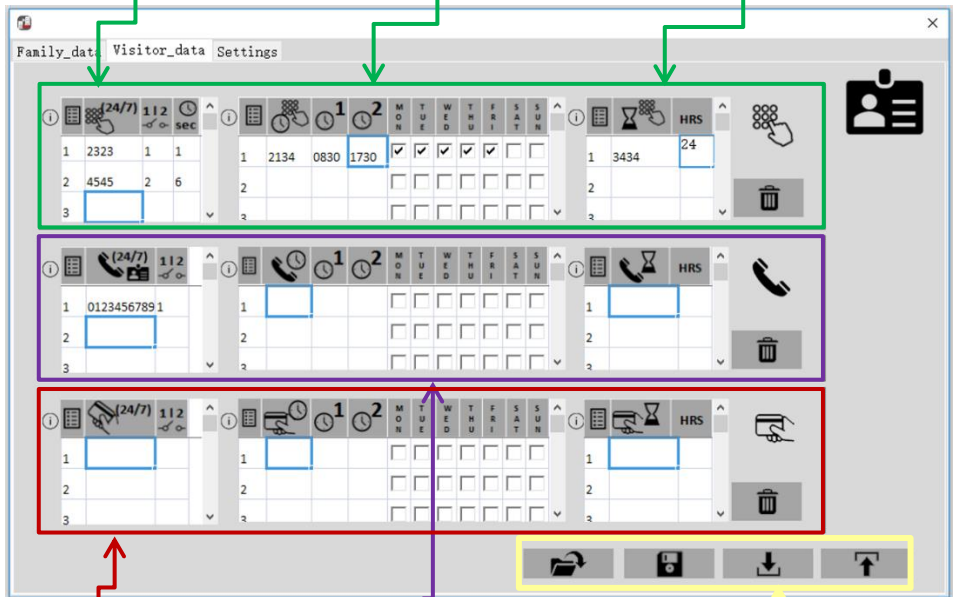

Selected models only – enter 50 visitor Prox card serial numbers here for 24/7 access, 20 time restricted Prox cards, and 20 temporary cards which auto expire from 1-168 hours

TIP: Any changes made on this tab must be saved or uploaded on this tab to take effect.

Use DOWNLOAD button to download and view all existing stored data.

Enter up to 50 visitor caller ID phone numbers for 24/7 access, 20 time restricted phone numbers, and 20 temporary phone numbers

Settings

Change default engineer code (9999)
or default manager code (5555)

Set auto trigger, latch and unlatch
times to create time clock auto control

Set ringing time to attempt
calling each number before
dialling the next number.

Change relay trigger times for relay trigger by
DTMF. Note: Keypad pin code relay times
override this setting when code entered

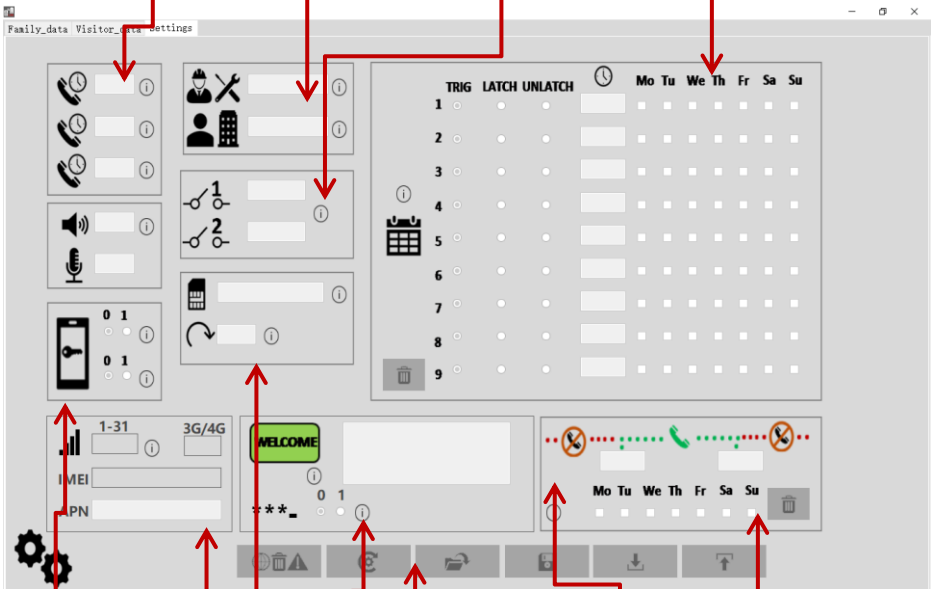

Enable latching relay
by DTMF
(default off)
Enable callerID by all
phone numbers
(default off)

Show / hide pin code
entry on screen

Enter new screen
instructions / welcome
message

Restore defaults and delete
all data on the intercom

Set start and end times for
visitor calls to be enabled.
Green section=enabled.
Red = disabled.
Use 24hr format, no colon

Set network APN for
4G connectivity (check
APN for your network.
This can usually be
found online)

Program the phone number of the
SIM card here, and set for daily
SMS (1) to recalibrate time every
day

The APP

Once the bulk of data has been entered, it is easy to maintain and upkeep visitor and resident data remotely with the free app on iphone and Apple.



Accept and allow all permissions (Android version shown)



To register first time, enter your name, email and cell phone number.



After you send the registration email, go back to the app screen & press SETTINGS

Program a NEW or EXISTING Job Site

Press SETTINGS to reveal the screen shown. Choose to create a NEW site or edit an existing one. Then you can begin programming.

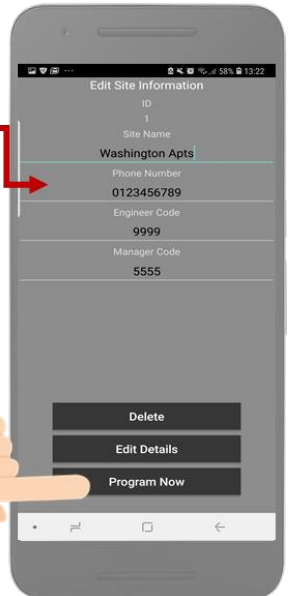

ANDROID Press & HOLD
Iphone use the "i" symbol

NOTE: Do not change engineers or managers codes on the APP unless they have already been changed in the intercom



Now you are ready to begin programming!

Programming Codes

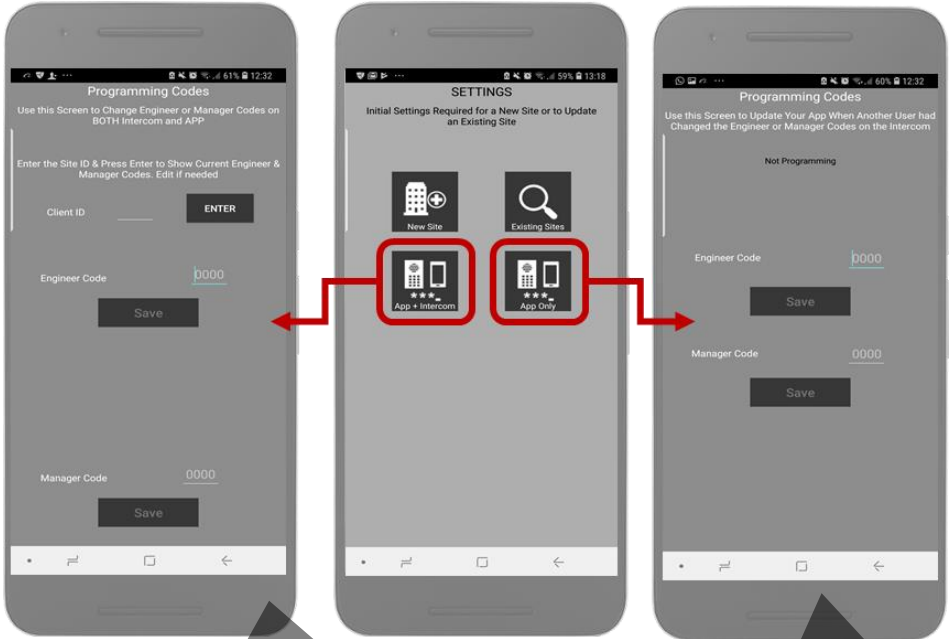

App AND Intercom Update
Use to change either the manager or engineer programming codes on BOTH the intercom and the APP.

App ONLY update
Use to update the APP, typically when another user has changed the programming codes on the intercom from another phone.

Note: This app sends SMS programming strings to the intercom as shown and it should reply with OK message. On iPhones, due to restrictions by Apple, you must confirm the SMS as shown. Android devices will auto send the SMS in the background.

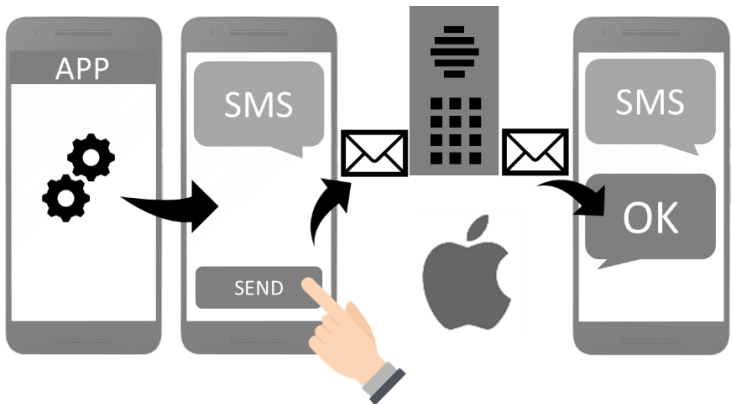

Programming

Now that you have either entered a new client, or selected an existing client from the client list, you are now ready to begin programming.



Step1: Check Reception

Go to MORE>INFORMATION to reveal the screen shown. Press the reception check button. On Android the app will automatically send a SMS string (*20#) to the intercom.

Due to Android and Apple security, users will be taken to their SMS screen to confirm the SMS before it will send.

The intercom should reply with a signal level between 1 & 31.

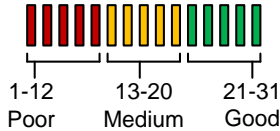

For good performance, signal level should be at least 13 or better on 3G or 4G and 14 or better on 2G.

TIP: If signal is lower than recommended, then take IMMEDIATE action. Change network if possible, or use an optional high gain antenna. Check power cable is within recommended specification. (Poor power cable can lower reception).

Note: SMS string= *20#



Step2: Set APN (for VOLTE / 4G voice calling)

This feature may need to be set in order to make 4G voice calls. Check the APN of your provider and then enter it in the blue section below and send as SMS to the intercom

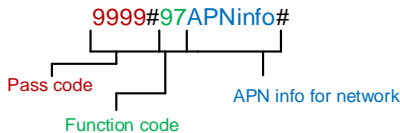

Step3: Reboot the Intercom

The intercom will need to be rebooted in order to log on to the network with the new APN which you have stored. If you send another reception check (*20#), you may find that if it was on 3G signal strength before, that it is now on 4G signal.



Add a Family(s)

Add up to 3 numbers for a family or resident, one code, and up to 3 proximity cards (Note: cards have serial numbers printed on them which can be added to the fields as shown).

Select Multi for multi family system

Note: Keypad codes for residents MUST BE 6 DIGITS LONG!

Add Optional Prox Cards
Add card by serial number as shown.



SMS String:

9999#10#12345#Jones#987654321,987654321,987654321#123456#serial,serial,serial#

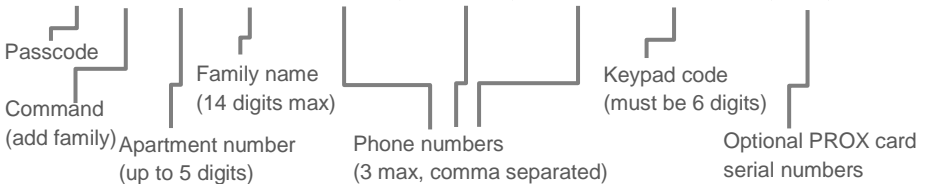

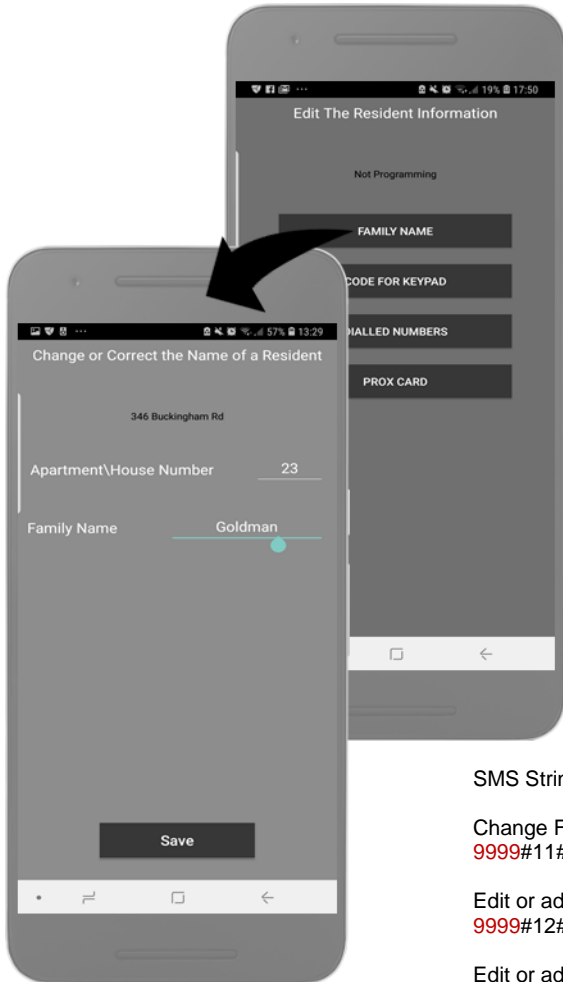

Edit family Details

Edit just the name, phone numbers, prox cards or keypad code individually for any family with the following buttons..

- Edit or add family Prox Card 1
9999#16#apartmentnumber#serialnumber#
- Edit or add family Prox Card 2
9999#17#apartmentnumber#serialnumber#
- Edit or add family Prox Card 3
9999#18#apartmentnumber#serialnumber#

SMS Strings

- Change Family Name
9999#11#apartmentnumber#newname#
- Edit or add first Phone Number
9999#12#apartmentnumber#phonenumber#
- Edit or add second Phone Number
9999#13#apartmentnumber#phonenumber#
- Edit or add third Phone Number
9999#14#apartmentnumber#phonenumber#
- Edit or Add Family Door Code
9999#15#apartmentnumber#doorcode#
- Delete a Family & all details
9999#25#apartmentnumber#

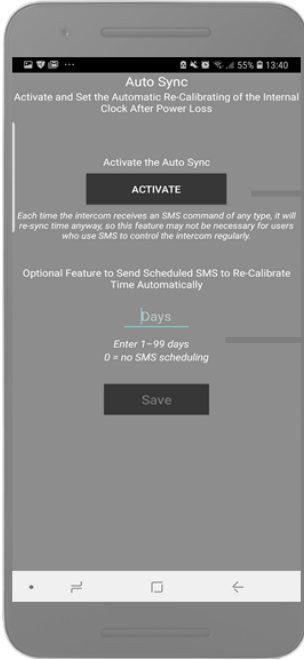

Activate Auto Sync

If you are using time sensitive features, such as time restricted access control, or auto opening and closing of gates at pre-set times of the day and week, then it is important to activate the auto sync.

This intercom reads the current date and time from an incoming SMS message and re-calibrates its time from that.

Activating this button sends the intercom its OWN SIM card phone number. The intercom will then send ITSELF an SMS after a power loss to re-establish correct time.

Use this feature to have the intercom send itself a SMS on a schedule. This is useful to maintain proper time for summer daylight saving for example. NOTE: Network charges may apply for SMS messages. Check with your provider.

SMS Strings

Store Intercom OWN phone number for time sync after reboot
9999#54#SIMphonenumber#

Activate Scheduled SMS
9999#55#days# (00=no SMS, 01=daily, 02=every 2 days etc)

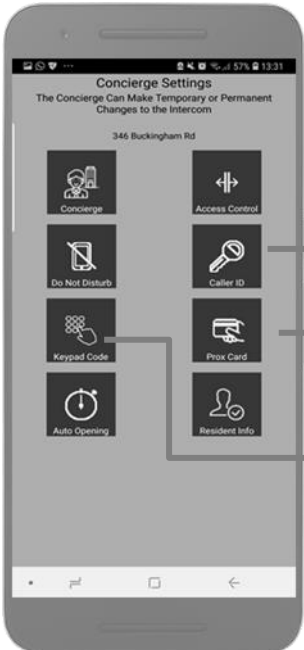

Add visitor access

You can add visitor keypad codes, or visitor caller ID access, and proximity cards for any visitors who are non-residents.

CallerID (enter by calling intercom and CLIP caller recognition)

Proximity card access for visitors

Keypad code access for visitors

A closer look at Keypad codes..

There are 3 types of visitor keypad codes..

1. **50** permanent codes which can be used 24/7.
2. **20** temporary codes, which auto expire in a pre-set number of hours.
3. **20** time restricted codes which can only be used at pre-set times and days of the week.

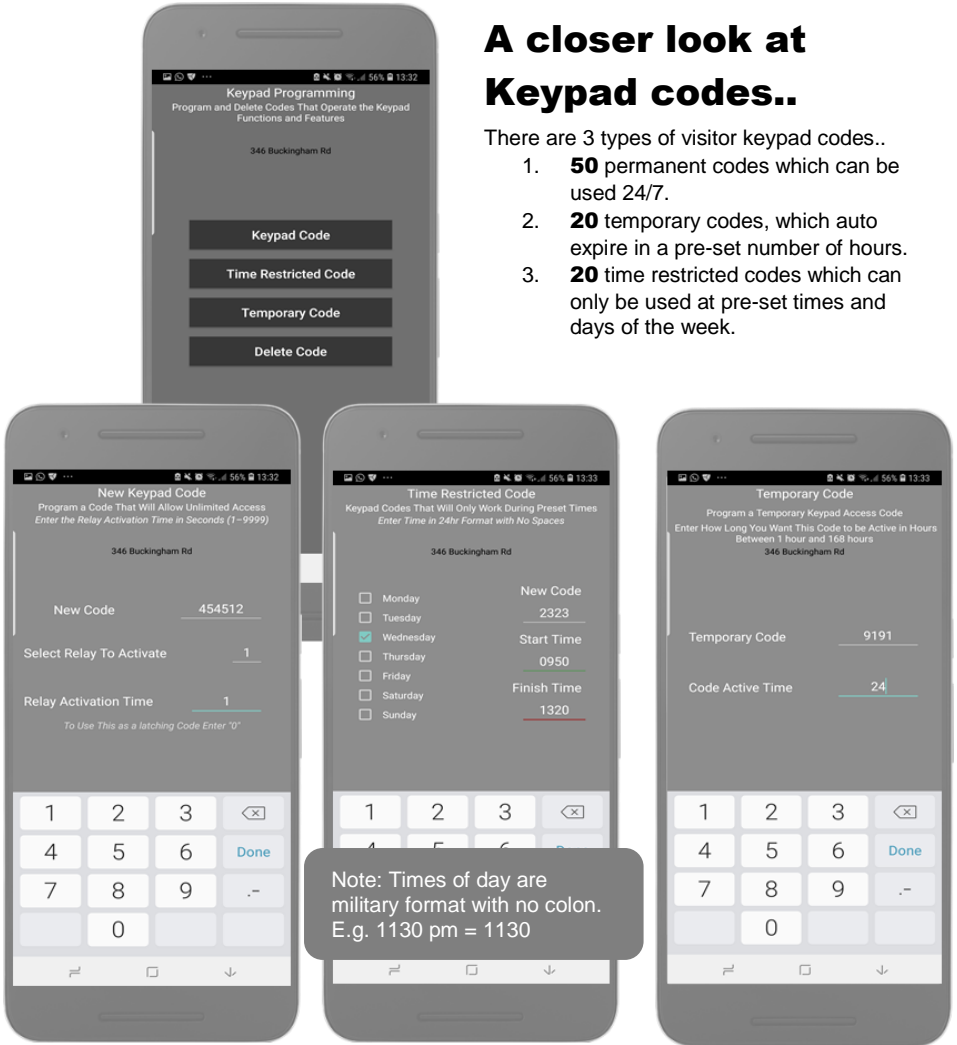

SMS Strings

Store permanent code

9999#81#Y#code#time# (Y= 1 or 2 for relay 1 or 2, code = 4 digit keypad code, time = relay time in secs from 1-99. 0 = latch code)

Store temporary code

9999#82#hours#code# (hours = number of hours a code is active for, from 1 – 999 hours)

Store time restricted code

9999#83#day,day,day#time1,time2# code# (day=mon,tue,wed,thu,fri etc. Time1=start time, Time2= end time. Code = 4 digit keypad code)

Delete Code

9999#84#code# (delete a known code) or **9999#84#*#** (delete all stored codes)

A closer look at Prox cards

There are 3 types of visitor cards..

1. **50** permanent cards which can be used 24/7.
2. **20** temporary cards, which auto expire in a pre-set number of hours.
3. **20** time restricted cards which can only be used at pre-set times and days of the week.



Cards have a 10 digit serial number printed as shown. Enter this to add a card.

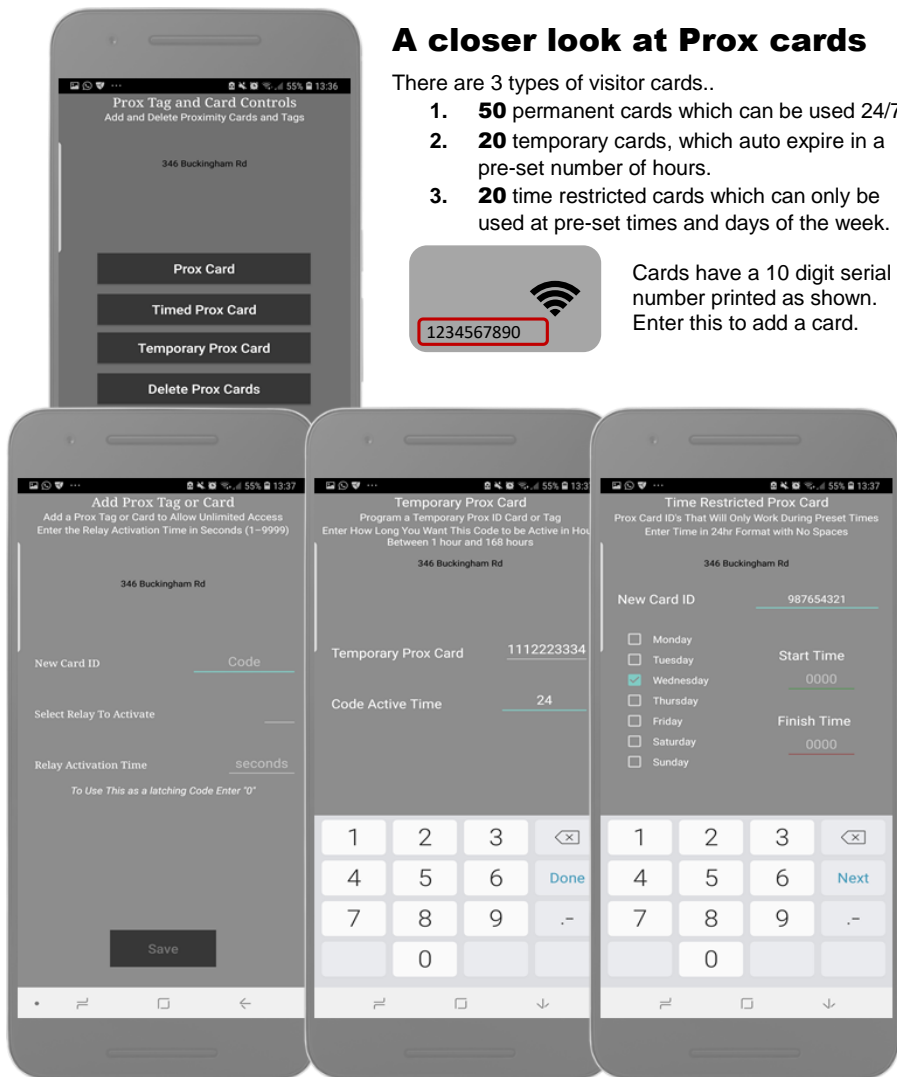

SMS Strings

Store permanent card

9999#61#Y#serial# (Y= 1 or 2 for relay 1 or 2, serial = 10 digit prox card number)

Store temporary card

9999#62#hours#serial# (hours = number of hours a code is active for, from 1 – 999 hours)

Store time restricted card

9999#63#day,day,day#time1,time2# serial# (day=mon,tue,wed,thu,fri etc. Time1=start time, Time2= end time, serial = 10 digit prox card number)

Delete Card

9999#64#serial# (delete a known code) or 9999#64*# (delete all stored codes)

A closer look at CallerID

IMPORTANT:

All resident phone numbers that are stored can automatically have callerID access without having to store the numbers in this section again. Go to CONCIERGE/ACCESS CONTROL to activate CallerID for all residents and visitors.

There are 3 types of CallerID access for VISITORS:

1. **50** visitor phone numbers with 24/7 access.
2. **20** visitors with temporary access (expires automatically after pre-set time)
3. **20** time restricted phone numbers which can only be used to gain access at pre-set times and days of the week.



SMS Strings

Store permanent callerID phone numbers

9999#71#Y#**phonenumber**# (Y=1 or 2 for relay 1 or 2)

Store temporary phone number

9999#72#**hours**#**phonenumber**# (hours = 1-999 hours then this number is auto deleted again)

Store time restricted phone number

9999#73#**day,day,day**#**time1,time2**# **phonenumber**# (day=mon,tue,wed,thu,fr etc. Time1=start time, Time2= end time)

Delete Phone number

9999#74#**phonenumber**# (delete a known code) or 9999#74#*# (delete all stored visitor)

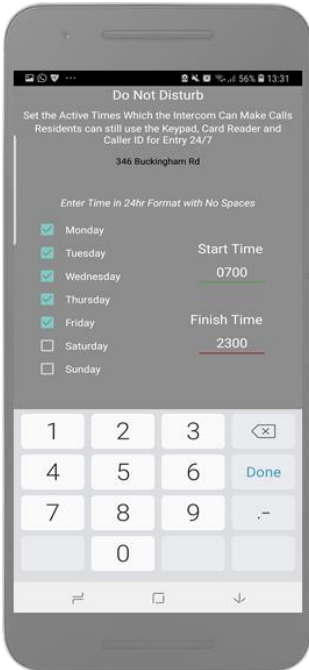

Do Not Disturb

On this screen you can prevent residents receiving calls from visitors after a set time at night. This can be useful if there are antisocial callers or residents do not want disturbed at weekends.

Enter time in 24hr format, no colon. Eg 8.20am = 0820. 11.40pm = 2340.

Visitors can receive calls BETWEEN the START and FINISH times only on the days selected.

SMS Strings

Add Do Not Disturb Time

9999#90#day,day,day#time1,time2#

(day=mon,tue,wed,thu,fri etc. Time1=start time, Time2=end time)

Delete all Do Not Disturb Times

9999#90#*#*#

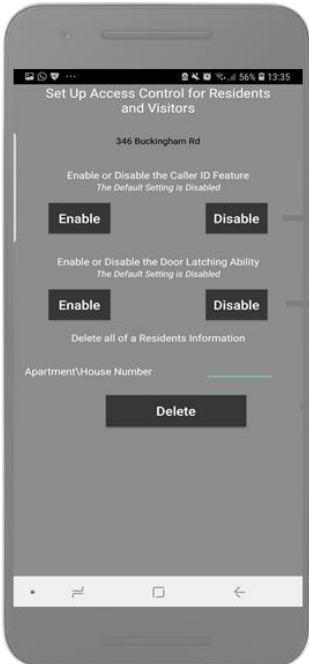

Access Control

If residents are to be able to use callerID to open the gate or door, then enable here. Take care, as residents can miss-dial the intercom in error!

Enable if residents should be able to latch or hold open gates or door. This is not recommended on larger installs as frequently a gate can be latched in error and result in a service call.

Quick delete a resident and all details.

SMS Strings

Enable callerID for residents

9999#35#X# (X=0 to disable. X=1 to enable)

Enable latching ability on received calls by residents

9999#36#X# (X=0 to disable. X=1 to enable)

Quick Delete a resident to prevent access

9999#25#apartment#

Auto Opening

You can use the internal time clock feature to hold open gates at pre-set times and days of the week. For gates that are on step by step operation, set trigger times to activate opening and closing. For auto-closing gates, set LATCH times to open, and then set separate UNLATCH times to close again. Up to 9 SMS event messages can be sent in total.



Toggle between trigger, latch and unlatch

Enter time in 24hr format, no colon. Eg 8.20am = 0820. 11.40pm = 2340.

SMS Strings

Delete all automatic relay events
5555#*#

Add Auto opening / closing times

5555#X#day,day,day,day#time#

Manager Pass code

- 1= Relay 1 trigger
- 2= Relay 1 latch
- 3= Relay 1 unlatch
- 4= Relay 2 trigger
- 5= Relay 2 latch
- 6= Relay 2 unlatch

Time in 24hr format. No colon. E.g. 11.15pm = 2315

Add days, 3 digits, e.g.
 mon,tue,wed,thu,fri,sat,sun.
 Separated by comma.

Enquire Resident Info

Enter the apartment or house number and the intercom will reply with all data, numbers and codes stored against that resident.



SMS String

Enquire resident
9999#26#apartment#

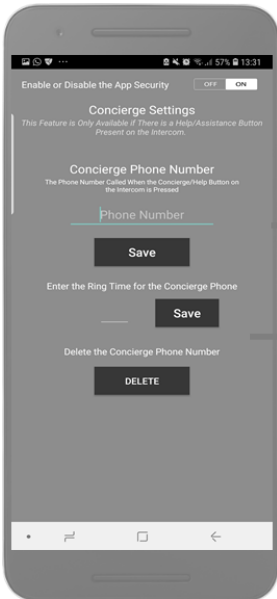

Concierge / assistance

Used in panels with a HELP / Assistance or concierge button.

Enter a number here which will be called when a visitor needs assistance. Useful for car parks and barriers etc.

Calling time to ring the assistance number before cancelling and ending the call.

SMS Strings

Enter Concierge / help or assistance number
9999#56#1#phonenumber#

Delete Concierge / help or assistance number
9999#56#1#*#

Set ringing time to call number
9999#57#XX# (XX = seconds, default = 20)

More Settings Screen

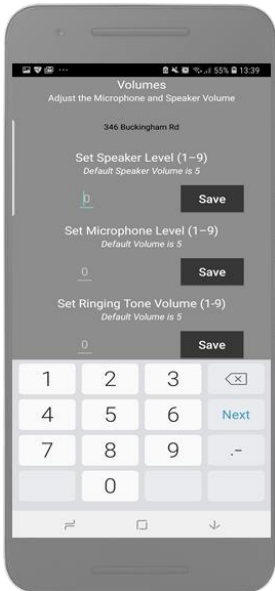
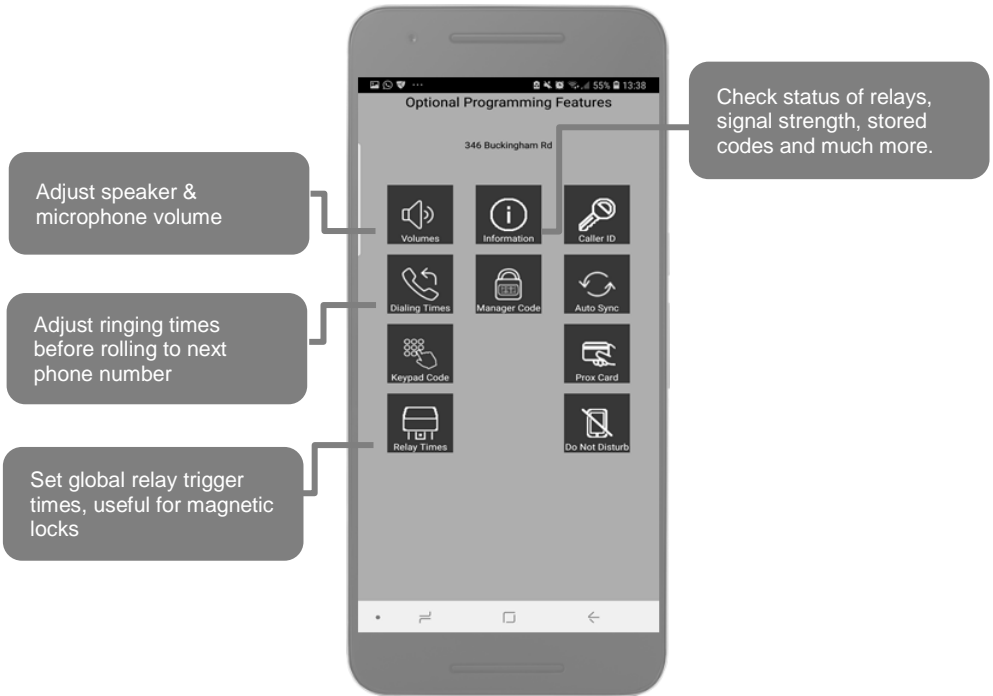

Volumes

If residents experience significant echo, reduce the microphone and speaker levels as low as possible. Default setting = 5. Range = 1-9.

SMS Strings

Set Speaker Volume
9999#30#X# (X = 1-9, default = 5)

Set Microphone Volume
9999#31#X# (X = 1-9, default = 5)

Set ring tone Volume (not used yet)
9999#32#XX (X = 1-9, default = 5)

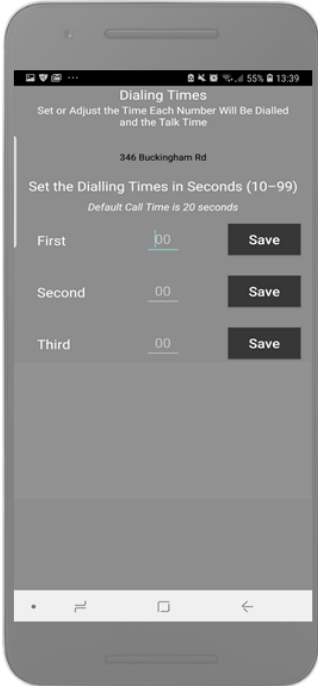

Dialling Times

Use these to adjust the ringing time the intercom will call a number before it will stop and call the next. This is useful to avoid voicemail from picking up a call.

Default dialling time is 20 seconds (from button press)

SMS Strings

Set first ringing time

9999#21#XX# (Default = 20. Range = 1-99)

Set second ringing time

9999#22#XX# (Default = 20. Range = 1-99)

Set third ringing time

9999#23#XX# (Default = 20. Range = 1-99)



Relay Times

Adjust relay times to suit perhaps a magnetic lock that requires a 7-10 second unlock time to allow pedestrians time to press the door and open.

Default relay time is 1 second.

SMS Strings

Set Relay 1 time:

9999#50#XXXX# (XXXX = time in secs from 1-9999)

Set Relay 2 time:

9999#51#XXXX# (XXXX = time in secs from 1-9999)

Information Screen

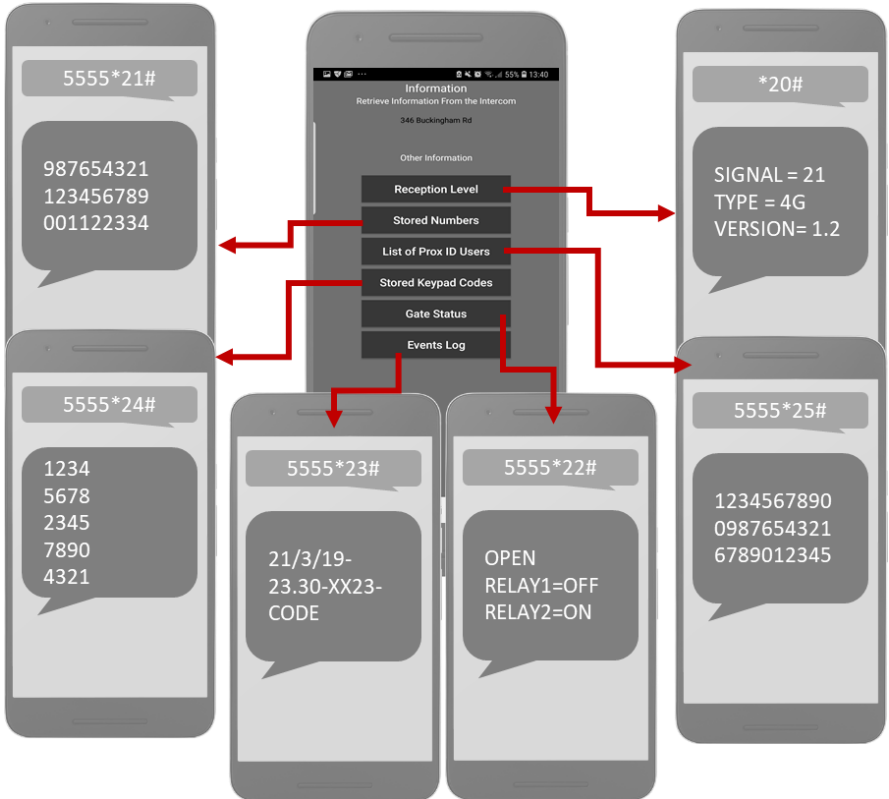

This screen allows the engineer or manager to be able to check multiple things on the intercom. Please note the following points..

-5555 is the default managers code shown.

-Stored callerID numbers, keypad codes and prox users are VISITOR credentials only. These do not list RESIDENT credentials. To do that, enquire on each resident individually in the appropriate screen.

In the activity log screen, each event is stored under a code. For example if a visitor uses caller ID to open the gate, it will be shown as date – time – number – CID. If a keypad code is used, it will be shown on the next line as date – time – pin number – CODE.

Manager Controls of Gate / Door

This screen allows the installer or manager to manually trigger the gate.

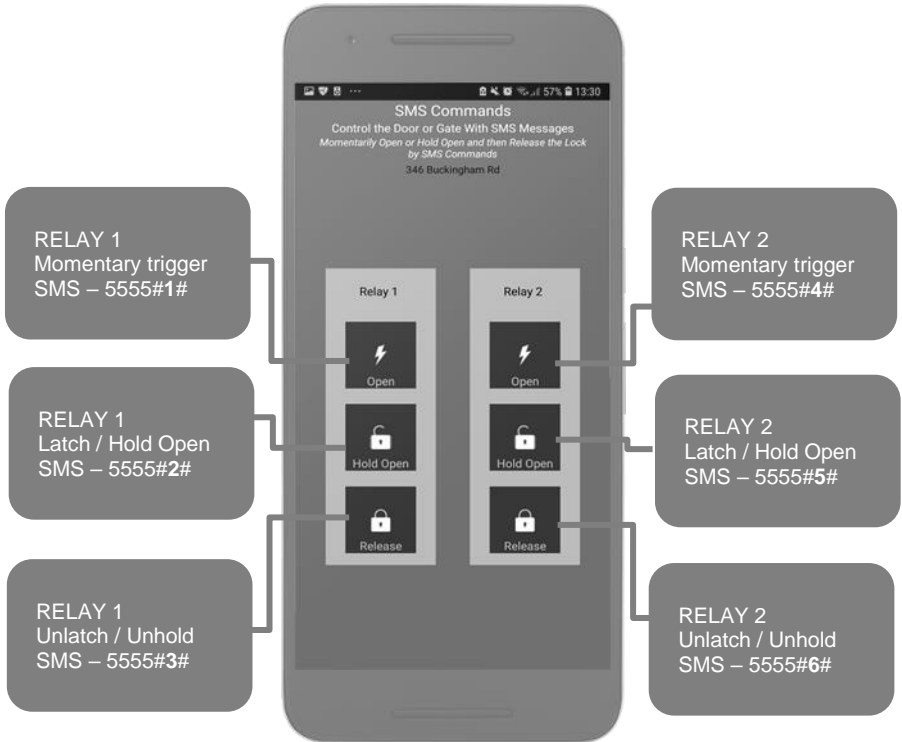

Calling a Resident

Scroll Method



- 1: Scroll Up/Down
- 2: Press #/CALL

Direct Dial Method



- 1: Enter apartment number
- 2: Press #/CALL

Using Keypad Codes



1: Enter 6 digit resident code, or 4 digit visitor code.

2: Press * to open door.

Receiving A Call and Opening Gates / Door

Visitors can press the call button, which will initiate a call from your intercom to the designated phone numbers which will have been programmed by your installer.

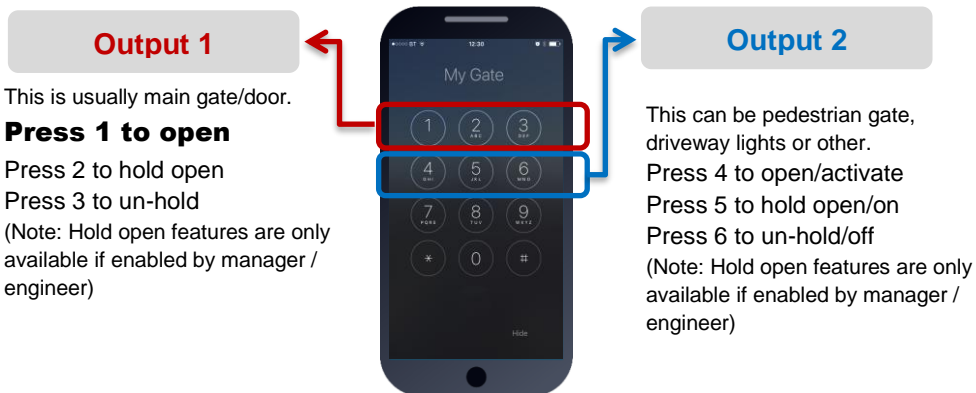
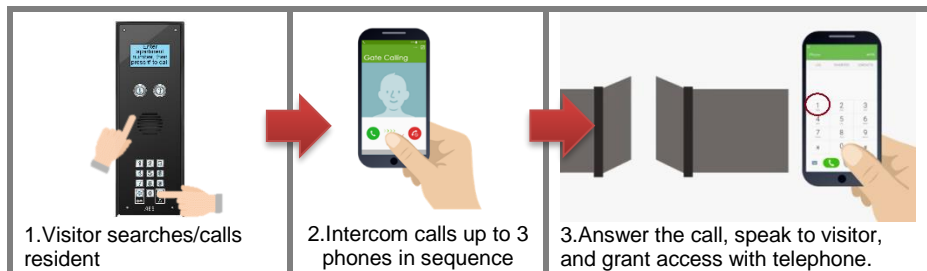

Access Control by Calling the intercom (CallerID)



All residents can call the intercom to gain access at no call charge using CallerID (CLIP) display.

To open, simply call the intercom phone number from a stored number and the relay will trigger as per programmed.

TIP. This feature must be enabled in settings first (default disabled)

Complete list of parameters

The table below show the complete list of features. *Programming messages below must begin with 9999# (assuming 9999 is still the programming passcode)...*

Edit a family name

9999#11#12345#Jones#

Edit or add family number

9999#12#12345#number# (edit first dialled number)

9999#13#12345#number# (edit second dialled number)

9999#14#12345#number# (edit third dialled number)

Edit a family door code

9999#15#12345#code#

Edit or add a family card

9999#16#12345#serial#

9999#17#12345#serial#

9999#18#12345#serial#

Set ringing time to call first number

9999#21#XX#

Set ringing time to call second number

9999#22#XX#

Set ringing time to call third number

9999#23#XX#

Delete a family and all details

9999#25#12345#

Enquire details on a family

9999#26#12345# (This will reply with all the details stored about this apartment).

Set Speaker Volume

9999#30#X# (X=1-9)

Set Mic Volume

9999#31#X# (X=1-9)

Enable / Disable caller ID for residents

9999#35#1# (1=ON, 0=OFF. Default=0)

Enable / Disable latching ability by residents

9999#36#1# (1=Enabled, 0=Disabled. Default=0)

Change Engineers programming code

9999#40#XXXX# (Default 9999)

Change managers user code

9999#41#XXXX# (Default 5555)

Change Relay 1 trigger time

9999#50#XXXX#

Change relay 2 trigger time

9999#51#XXXX#

Store intercom own phone number for AUTO self SMS sending on reboot.

9999#54#XXXXXXXXXX#

Activate auto SMS sending (to re-calibrate time every day)

9999#55#XX# (0=off, 1=SMS every day, 2=SMS every 2 days etc)

Store phone number for manager / concierge / assistance call button to call when pressed

9999#56#1#XXXXXXXXXX#

Delete manager phone number

9999#56#1#*#

Store ringing time for manager / concierge / assistance phone number

9999#57#XX#

SMS control messages

Either engineer or of manager can control the relays by SMS but users cannot.

9999#1# - Trigger relay 1

9999#2# - Latch relay 1

9999#3# - unlatch relay 1

9999#4# - Trigger relay 2

9999#5# - Latch relay 2

9999#6# - Unlatch relay 2

Same commands can be carried out with 5555 passcode.

To store a visitor code (50 max)

9999#81#Y#code#time# (Y= 1 or 2 for relay 1 or 2, time=relay trigger time, 1-99 seconds)

To store a temporary visitor code (20 max):

9999#82#hours#code# (hours is number of hours code is active for, max 999 hours)

To store a time restricted visitor code (20 max):

9999#83#day,day,day,day,day,day,day,day#time1,time2#code#

To delete a visitor code:

9999#84#code#

To delete all visitor codes:

9999#84#*#

To store visitor caller ID number (50 max)

9999#71#Y#telephone# (Y = 1 or 2 for relay 1 or 2)

To store visitor temporary called ID number (20 max)

9999#72#hours# telephone # (hours is qty of hours the caller ID number can work for 999 max)

To store a visitor time restricted caller ID number (20 max)

9999#73#day,day,day,day,day#time1,time2#telephone#

To delete a visitor caller ID number:

9999#74#number#

To delete all visitor caller ID numbers:

9999#74#*#

To store prox card (50 max)

9999#61#Y#serial# (Y = 1 or 2 for relay 1 or 2)

To store temporary visitor Prox card (20 max)

9999#62#hours#serial# (hours can be up to 999 max)

To store time restricted prox card (20 max)

9999#63#day,day,day,day,day#time1,time2#serial#

To delete a prox card:

9999#64#serial#

To delete All prox card:

9999#64##

SMS Checking messages

*20# (check reception, version and date etc)

5555*21# (Check stored visitor caller ID numbers only. Do not check stored family numbers).

5555*22# (Check gate status)

5555*23# (shows last 20 events)

5555*24# (Check stored visitor keypad codes)

5555*25# (Check stored visitor prox cards)

To Add an automatic relay event

5555#1#day,day,day#time# (1=trigger, 2=latch, 3=unlatch)

To delete all auto relay events..

5555##

To set Do Not Disturb Times

9999#90#day,day,day#time1,time2#

To delete all Do Not Disturb Times

9999#90##

To set APN for 4G connectivity)

9999#38#apninfo#

To edit LCD welcome/instruction message

9999#58#entertext# (# character not permitted, to display # use "@" character in SMS string)

To enable/disable display of pin code being entered on screen

9999#37#X# (X=0 to disable, X=1 to enable, default = 0)

Complete restore defaults on unit

9999#99#

Troubleshooting guide

Q. The unit will not power up. No LEDs on.

A. Check power supply voltage at intercom is 23.4v DC or more. Cable length from PSU to intercom should be less than 25 feet and in 14 gauge for longer distances. See guide. Check the fuse.

Q. The unit powers up but is not showing network reception or will not respond to SMS.

A. This means the unit is not able to detect the network for some reason.

- Power off the unit, remove the SIM and check it in a mobile phone to verify it can make a call and has calling credit.
- Disable any PIN code request if active on the SIM card.
- Check the SIM is a standard voice capable SIM. If you are unsure, contact your SIM card provider to verify. Compatible networks are At&T and T-Mobile.
- Check the reception is medium or good. Poor reception is not sufficient.
- Power off, remove the SIM, use fine sand paper to lightly sand the SIM pads and contacts on the GSM unit, lightly bend the contacts upwards so that they make better contact with the SIM and try again.

Q. The unit calls the first number, but there is not enough time to answer before it diverts to the next number.

A. Increase the no answer time as per programming instructions.

Q. The unit calls the first number but voicemail comes on before it can ring the second number.

A. Decrease the no answer time as per programming instructions.

Q. The caller ID part does not work.

A. Residents have Caller ID disabled by default. Ensure this is activated if you want residents to use caller ID. If your number is a private or number withheld, then it will not work.

-Ensure the number is entered as you would normally dial it from another phone.

-For US customers, ensure the numbers have been entered with a leading 1. If this does not work, try again without the leading 1.

Q. There is no audio from the gate, but the person at the gate can hear ok.

A. This can be due to low reception or excessively long power cables.

-Check reception level by *20#.

-Change SIM card if necessary to another network which may have better coverage.

-Purchase a high gain antenna.

This may also be caused by a defective microphone, water on a microphone from a sprinkler for example, or dirt/insects blocking the microphone hole. If reception is optimum and the problem persists, contact your supplier or installer.

Q. The audio quality that can be heard on the remote telephone is poor or humming (buzzing).

A. A small amount of GSM buzz can be considered normal on GSM intercoms, but not so much that causes inability to hear the person speaking. This is a symptom of poor reception. Try above steps on checking and improving reception. Consider fitting an external high gain antenna. Move the antenna further away. Remove any short bends in the antenna. Ensure the spare antenna cable is not rolled up inside the call station.

Q. The trigger keys do not work when the intercom calls a phone.

A. Check if you can hear the relay clicking at the gate when the keys are pressed during a call. If it can be heard, then the system is working, check wiring between the relay and the lock or gate panel. If the relays do not make a clicking sound, then check this feature on a different mobile cell

phone or landline. If it works on a different phone, check the settings on the phone in question under DTMF tones.

Failure of DTMF tones to operate correctly is also a symptom of low reception or insufficient power cabling. Check steps above on improving reception or addressing the power problem.

-Also check that the relays are not already latched with the *22# command. If they are latched, they need unlatched before the trigger keys will work.

-Sometimes excessively long power cables or thin power cables can cause this problem. Prove it by connecting a temporary extension lead and the power supply directly to the unit.

Q. The system was operating the gates fine, but now it will not trigger the gates.

99% of the time, this is caused by the user accidentally latching the relay. This latches the output relay permanently on. Send the intercom the following SMS *22#. The intercom should reply with a message detailing the relay status.. If it has been latched, then the message will state “the relay is ON”. In this case refer to the user guide to read how to unlatch it again.

Q. The unit no longer calls out to phones but I can make a call to it from my phone.

A – Check there is balance on the SIM card.

A – Switch off the power, remove the SIM, put it into a phone, and check that a call can be made from a phone. This will verify if the SIM is still working and in service.

Q. The Android App shows an error message “Command Failed” when I try to use a function.

A – Go to phone settings/application manager/cellbox prime/permissions, and ensure all permissions are turned ON. Also ensure the app settings screen has a valid phone number stored.

Change History

Key:

P = Panel version H = Hardware PCB version S = Software version

Version			Reason for change	Date
P	H	S		
1	1	2.8		

Warranty Terms

Please note, by installing this product, you are accepting the following warranty terms:

1. The manufacturer's warranty is a "return to base" 2 year warranty from date of manufacture. This means that any suspected defective components or items are returned to the manufacturer's agent for investigation and diagnosis, and returned at the cost of the customer.
2. The warranty does not cover, nor is the manufacturer or agent responsible for any of the following whatsoever: Storm damage, lightning or surge damage, flooding, accidental damage, vandalism or deliberate damage, un-explained corrosion or unusually harsh environments, failure of telephone networks, future un-interoperability between the product and network providers which cause mal-function due to changes implemented by the phone providers after manufacture of the product, or that which is outside of control of the manufacturer (e.g. 2G, 3G switch off, removal or inability to obtain VOLTE service), and damage due to not proper installation.
3. The manufacture in no way accepts liability for any of the following incurred due to a product defect: Cost of attending site, inconveniences, labour rates, time lost, loss to or damage to property, security breaches, late payment clauses or breaches of any contracts between the installer and the client.
4. This is a profession install product only. The product is a component of an overall system. Therefore, it is the responsibility of the installer to certify the safety and compliance of the overall finished system. As soon as this product is fixed to another item, or connected to another third-party device, then the product has been modified, and compliance with local regulations in the country of install is strictly the responsibility of the installer.
5. Re-stocking fees may apply to items returned that are found to be non-defective. Complete units will also attract a re-stocking fee if returned for credit, regardless if a defect is discovered or not. Re-stocking fees may vary depending on the condition of the item being returned, and whether it can be determined as in brand new condition. The warranty terms do not entitle customers to an automatic full refund. For more details on returns procedures and re-stocking fees, contact the agent.
6. Items with physical signs of surge damage are not covered by warranty. Items without visible signs of surge damage will only be covered by warranty provided photographic evidence is provided from site showing surge protection has been installed as per instructions in this manual.

EU-RED Declaration of Conformity

Manufacturer: Advanced Electronic Solutions Global Ltd

Address: Unit 4C, Kilcronagh Business Park, Cookstown, Co Tyrone, BT809HJ, United Kingdom

We/I declare, that the following equipment (GSM Cellular Intercom System), part numbers:
Multiple Model kit part numbers: PRIME6-MULTI-LT-4GE.

Complies with the following essential requirements for 2014/53/EU:

ETSI draft EN 301 489-1 V2.1.1 (2017-02) (Electromagnetic compatibility)
ETSI draft EN 301 489-52 (2016-11) (Electromagnetic compatibility, specific to cellular)
(2G bands 900/1800, 3G band 1,8 LTE bands 1, 3, 7, 8, 20).
Test report number LCS181101028AEA

ETSI EN 301 511 V12.5.1 (2017-03) (3.2 of directive 2014/53/EU)
ETSI TS 151 010-1 V12.8.0 (2016-05) (Digital cellular telecoms compliance)
Test report number LCS181101028AEB

ETSI EN 301 908-1 V11.1.1 (2016-07) (IMT Cellular networks, 3.2 of directive 2014/53/EU)
ETSI EN 301 908-2 V11.1.2 (2016-07) (CDMA spread / UTRA FDD)
Test report number LCS181101028AEC

ETSI EN 301 908-13 V11.1.2 (2017-07) (E-UTRA and UE standards)
Test report number LCS181101028AED

EN 62311 :2008 (Electromagnetic safety and human exposure)
Test report number: LCS181101028AEE

EN 60950-1, (A1, A11, A12, A2)
EN 62311

IEC 60950 (IT equipment safety)
Test report number: LCS181101029AS

The notified body is: Micom Labs (CAB number 2280).
This declaration is issued under the sole responsibility of the manufacturer.
Signed by:



Paul Creighton, Managing Director. Date: 4th Dec 2018

CE
2280

FCC

FCC ID: 2ALPX-PE-4GA
Main Model No: PRIME6-PROX-IMPX-PE-4GA

Caution: This device complies with part 15 of the FCC Rules. Operation is subject to the following two conditions: (1) This device may not cause harmful interference, and (2) this device must accept any interference received, including interference that may cause undesired operation.



Note: For legal reasons, telephone technical support is for registered and qualified product dealers only. Home owners and end users should contact their local dealer for product technical support.